

PRODUCT FEATURES

- High level of integration
- IGBT CHIP(Trench+Field Stop technology)
- Low saturation voltage and positive temperature coefficient
- Fast switching and short tail current
- Free wheeling diodes with fast and soft reverse recovery
- Industry standard package with insulated copper base plate and soldering pins for PCB mounting

- Temperature sense included

APPLICATIONS

- AC motor control
- Motion/servo control
- Inverter and power supplies

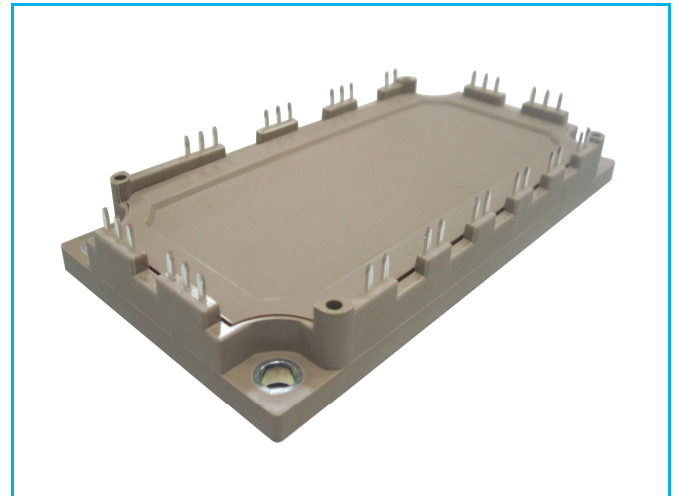

IGBT-inverter

ABSOLUTE MAXIMUM RATINGS($T_C=25^{\circ}\text{C}$ unless otherwise specified)

| Symbol | Parameter/Test Conditions | | Values | Unit |
|-----------|-----------------------------------|--|----------|------|
| V_{CES} | Collector Emitter Voltage | $T_J=25^{\circ}\text{C}$ | 1200 | V |
| V_{GES} | Gate Emitter Voltage | | ± 20 | |
| I_C | DC Collector Current | $T_C=25^{\circ}\text{C}, T_{Jmax}=175^{\circ}\text{C}$ | 110 | A |
| | | $T_C=95^{\circ}\text{C}, T_{Jmax}=175^{\circ}\text{C}$ | 75 | |
| I_{CM} | Repetitive Peak Collector Current | $t_p=1\text{ms}$ | 150 | |
| P_{tot} | Power Dissipation Per IGBT | $T_C=25^{\circ}\text{C}, T_{Jmax}=175^{\circ}\text{C}$ | 385 | W |

Diode-inverter

ABSOLUTE MAXIMUM RATINGS ($T_C=25^{\circ}\text{C}$ unless otherwise specified)

| Symbol | Parameter/Test Conditions | | Values | Unit |
|-------------|---------------------------------|---|--------|----------------------|
| V_{RRM} | Repetitive Reverse Voltage | $T_J=25^{\circ}\text{C}$ | 1200 | V |
| $I_{F(AV)}$ | Average Forward Current | | 75 | A |
| I_{FRM} | Repetitive Peak Forward Current | $t_p=1\text{ms}$ | 150 | |
| I^2t | | $T_J=125^{\circ}\text{C}, t=10\text{ms}, V_R=0\text{V}$ | 1250 | A^2S |

MacMic Science & Technology Co., Ltd.

Add: #18, Hua Shan Zhong Lu, New District, Changzhou City, Jiangsu Province, P. R .of China

MMG75W120X6TC

IGBT-inverter

ELECTRICAL CHARACTERISTICS ($T_C=25^\circ\text{C}$ unless otherwise specified)

| Symbol | Parameter/Test Conditions | | Min. | Typ. | Max. | Unit | |
|---------------|--|--|--|------|------|---------------|----|
| $V_{GE(th)}$ | Gate Emitter Threshold Voltage | $V_{CE}=V_{GE}, I_C=3\text{mA}$ | 5.0 | 6.0 | 6.5 | V | |
| $V_{CE(sat)}$ | Collector - Emitter Saturation Voltage | $I_C=75\text{A}, V_{GE}=15\text{V}, T_J=25^\circ\text{C}$ | | 1.75 | 2.15 | | |
| | | $I_C=75\text{A}, V_{GE}=15\text{V}, T_J=125^\circ\text{C}$ | | 2.05 | | | |
| | | $I_C=75\text{A}, V_{GE}=15\text{V}, T_J=150^\circ\text{C}$ | | 2.10 | | | |
| I_{CES} | Collector Leakage Current | $V_{CE}=1200\text{V}, V_{GE}=0\text{V}, T_J=25^\circ\text{C}$ | | | 1 | mA | |
| | | $V_{CE}=1200\text{V}, V_{GE}=0\text{V}, T_J=150^\circ\text{C}$ | | | 10 | | |
| I_{GES} | Gate Leakage Current | $V_{CE}=0\text{V}, V_{GE}=\pm 20\text{V}, T_J=25^\circ\text{C}$ | -400 | | 400 | nA | |
| R_{gint} | Integrated Gate Resistor | | | 7.5 | | Ω | |
| Q_g | Gate Charge | $V_{CE}=600\text{V}, I_C=75\text{A}, V_{GE}=15\text{V}$ | | 0.4 | | μC | |
| C_{ies} | Input Capacitance | $V_{CE}=25\text{V}, V_{GE}=0\text{V}, f=1\text{MHz}$ | | 5 | | nF | |
| C_{res} | Reverse Transfer Capacitance | | | | 220 | | pF |
| $t_{d(on)}$ | Turn on Delay Time | $V_{CC}=600\text{V}, I_C=75\text{A}$ $R_G=3.6\Omega,$ $V_{GE}=\pm 15\text{V},$ Inductive Load | $T_J=25^\circ\text{C}$ | | 100 | ns | |
| | | | $T_J=125^\circ\text{C}$ | | 120 | ns | |
| | | | $T_J=150^\circ\text{C}$ | | 130 | ns | |
| t_r | Rise Time | | $T_J=25^\circ\text{C}$ | | 34 | ns | |
| | | | $T_J=125^\circ\text{C}$ | | 36 | ns | |
| | | | $T_J=150^\circ\text{C}$ | | 36 | ns | |
| $t_{d(off)}$ | Turn off Delay Time | $T_J=25^\circ\text{C}$ | | 290 | ns | | |
| | | $T_J=125^\circ\text{C}$ | | 350 | ns | | |
| | | $T_J=150^\circ\text{C}$ | | 370 | ns | | |
| t_f | Fall Time | $T_J=25^\circ\text{C}$ | | 80 | ns | | |
| | | $T_J=125^\circ\text{C}$ | | 160 | ns | | |
| | | $T_J=150^\circ\text{C}$ | | 180 | ns | | |
| E_{on} | Turn on Energy | $V_{CC}=600\text{V}, I_C=75\text{A}$ $R_G=3.6\Omega,$ $V_{GE}=\pm 15\text{V},$ Inductive Load | $T_J=125^\circ\text{C}$ | | 9.7 | mJ | |
| | | | $T_J=150^\circ\text{C}$ | | 10.2 | mJ | |
| E_{off} | Turn off Energy | | $T_J=125^\circ\text{C}$ | | 5.7 | mJ | |
| | | | $T_J=150^\circ\text{C}$ | | 6.1 | mJ | |
| I_{SC} | Short Circuit Current | | $t_{psc} \leq 10\mu\text{s}, V_{GE}=15\text{V}$ $T_J=150^\circ\text{C}, V_{CC}=800\text{V}$ | | 280 | | A |
| R_{thJC} | Junction to Case Thermal Resistance (Per IGBT) | | | | 0.39 | K/W | |

Diode-inverter

ELECTRICAL CHARACTERISTICS ($T_C=25^\circ\text{C}$ unless otherwise specified)

| Symbol | Parameter/Test Conditions | | Min. | Typ. | Max. | Unit |
|-------------|---|---|------|------|------|---------------|
| V_F | Forward Voltage | $I_F=75\text{A}, V_{GE}=0\text{V}, T_J=25^\circ\text{C}$ | | 1.75 | 2.15 | V |
| | | $I_F=75\text{A}, V_{GE}=0\text{V}, T_J=125^\circ\text{C}$ | | 1.55 | | |
| | | $I_F=75\text{A}, V_{GE}=0\text{V}, T_J=150^\circ\text{C}$ | | 1.50 | | |
| t_{rr} | Reverse Recovery Time | $I_F=75\text{A}, V_R=600\text{V}$ $dI_F/dt=-2500\text{A}/\mu\text{s}$ $T_J=150^\circ\text{C}$ | | 160 | | ns |
| I_{RRM} | Max. Reverse Recovery Current | | | 128 | | A |
| Q_{RR} | Reverse Recovery Charge | | | 14.7 | | μC |
| E_{rec} | Reverse Recovery Energy | | | 5.8 | | mJ |
| R_{thJCD} | Junction to Case Thermal Resistance (Per Diode) | | | | 0.6 | K/W |

MMG75W120X6TC

NTC CHARACTERISTICS ($T_C=25^\circ\text{C}$ unless otherwise specified)

| Symbol | Parameter/Test Conditions | Min. | Typ. | Max. | Unit |
|-------------|---|------|------|------|------------|
| R_{25} | Resistance $T_C=25^\circ\text{C}$ | | 5 | | K Ω |
| $B_{25/50}$ | $R_2 = R_{25} \exp [B_{25/50}(1/T_2 - 1/(298.15 \text{ K}))]$ | | 3375 | | K |

MODULE CHARACTERISTICS ($T_C=25^\circ\text{C}$ unless otherwise specified)

| Symbol | Parameter/Test Conditions | Values | Unit | |
|------------|-----------------------------|----------------------------|-------|----|
| T_{Jmax} | Max. Junction Temperature | 175 | °C | |
| T_{Jop} | Operating Temperature | -40~150 | | |
| T_{stg} | Storage Temperature | -40~125 | | |
| V_{isol} | Isolation Breakdown Voltage | AC, 50Hz(R.M.S), t=1minute | 3000 | V |
| CTI | Comparative Tracking Index | | > 200 | |
| Md | Mounting Torque | Recommended (M5) | 2.5~5 | Nm |
| Weight | | | 300 | g |

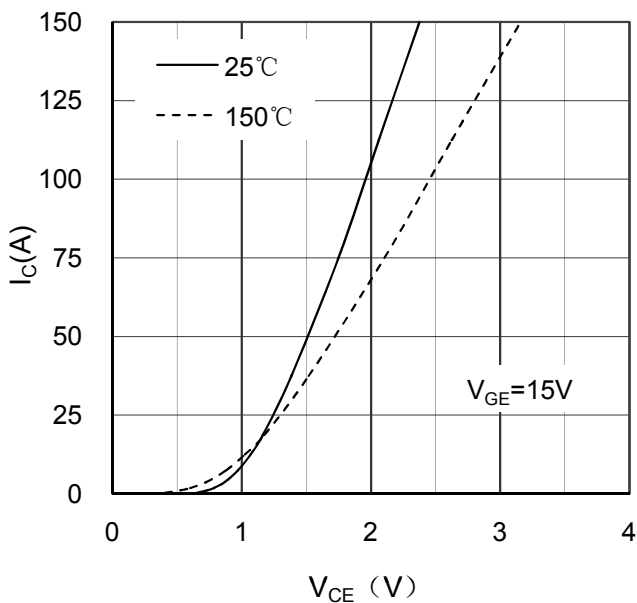

Figure 1. Typical Output Characteristics IGBT-inverter

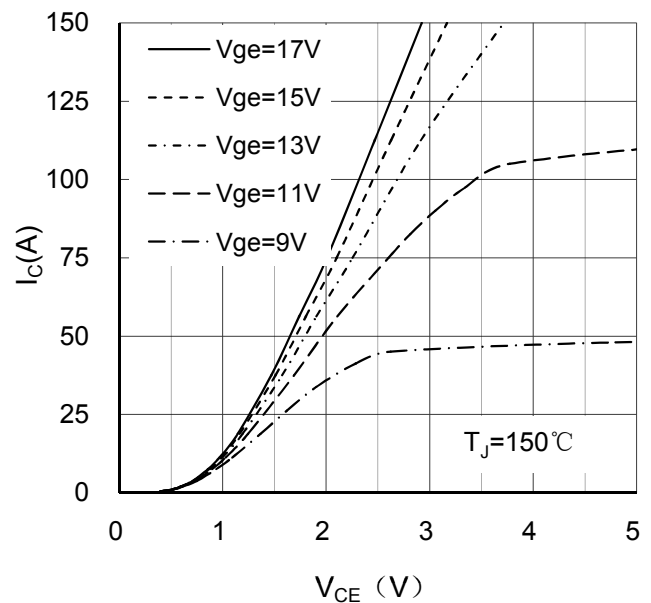

Figure 2. Typical Output Characteristics IGBT-inverter

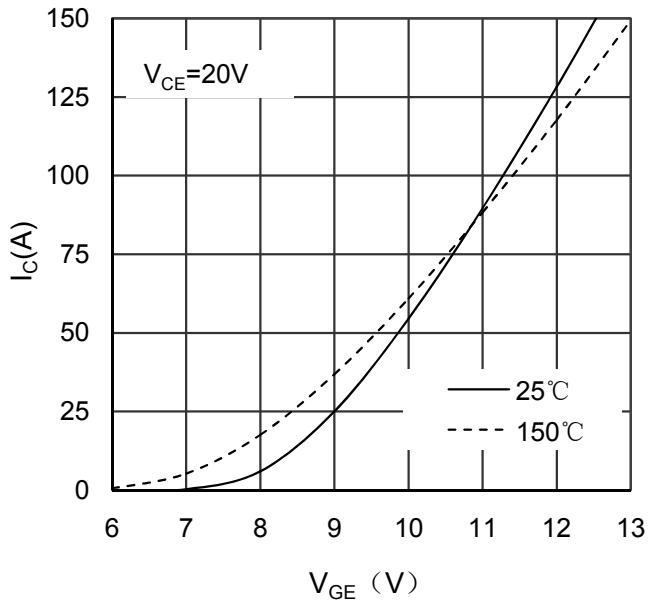

Figure 3. Typical Transfer characteristics IGBT-inverter

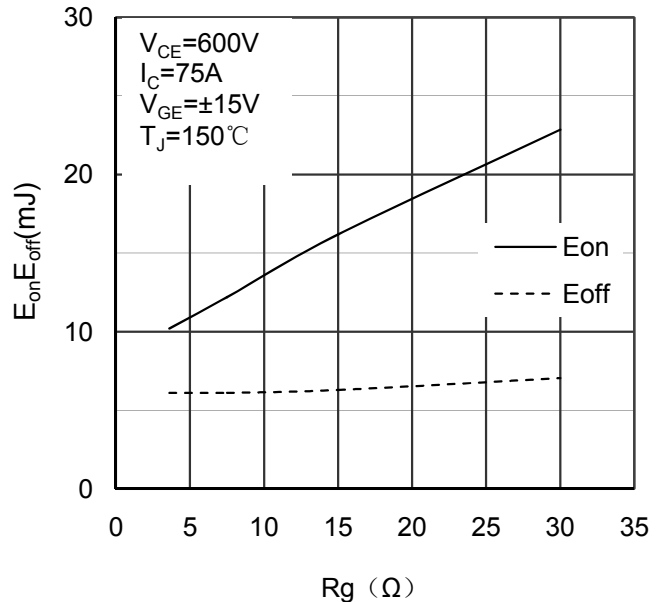

Figure 4. Switching Energy vs Gate Resistor IGBT-inverter

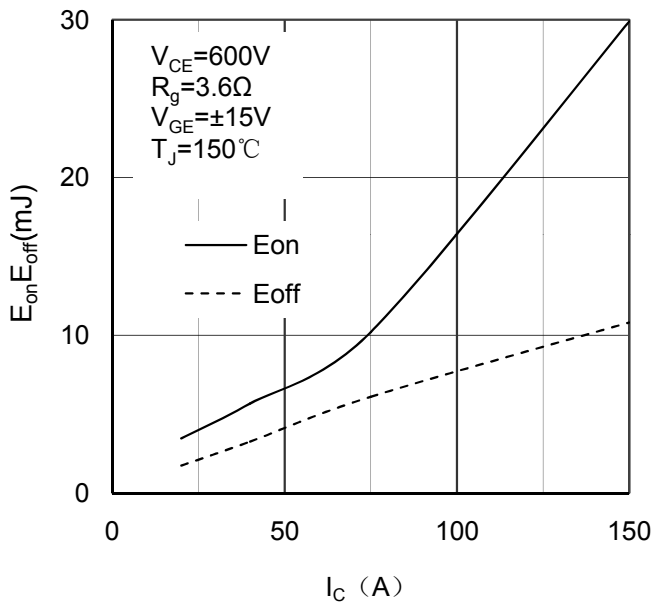

Figure 5. Switching Energy vs Collector Current IGBT-inverter

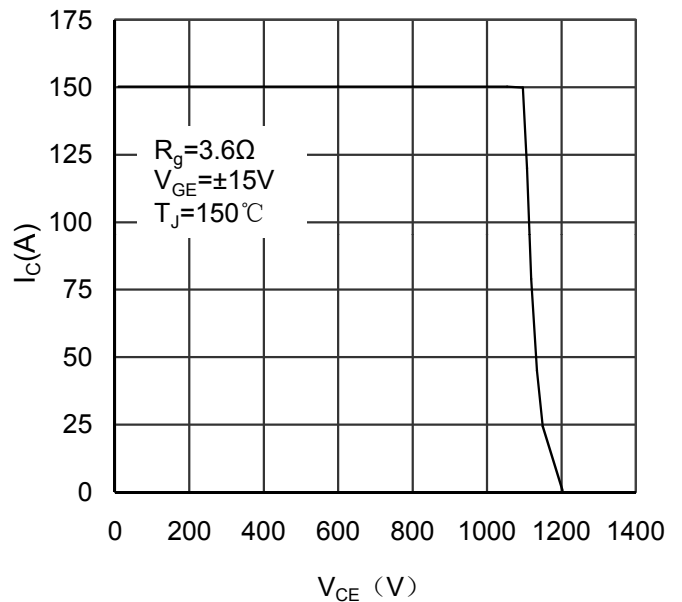

Figure 6. Reverse Biased Safe Operating Area IGBT-inverter

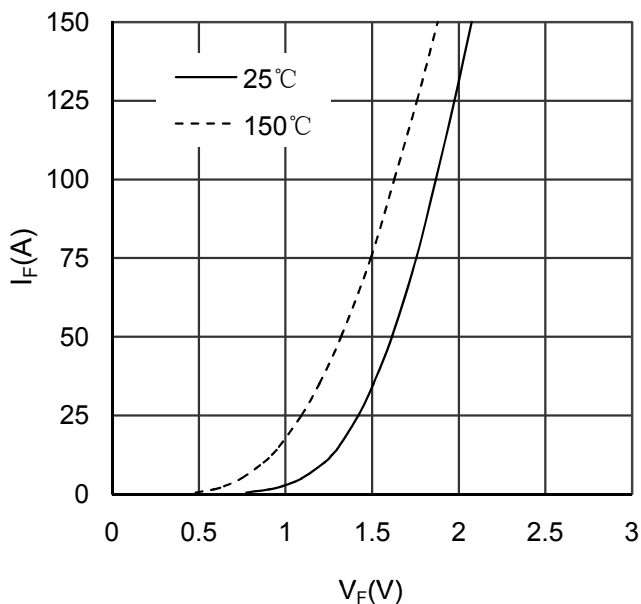

Figure 7. Diode Forward Characteristics Diode -inverter

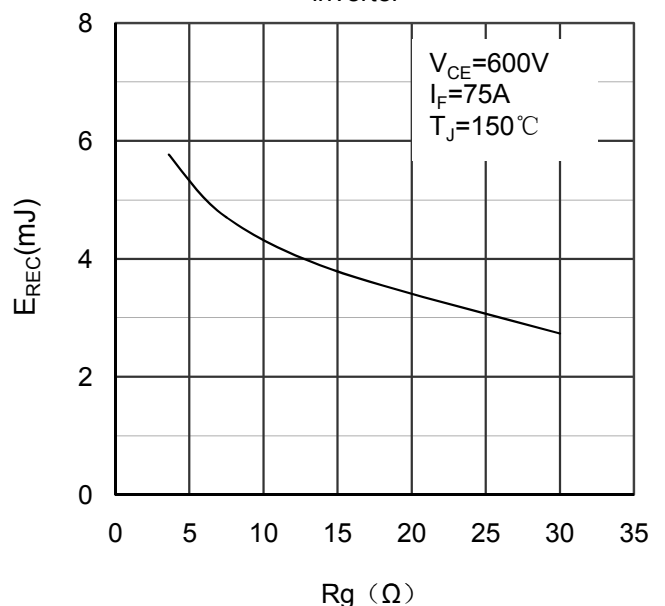

Figure 8. Switching Energy vs Gate Resistor Diode -inverter

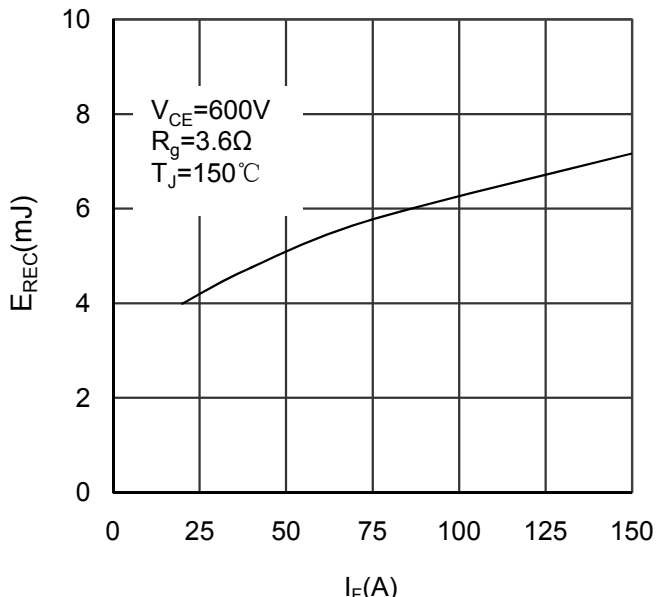

Figure 9. Switching Energy vs Forward Current Diode-inverter

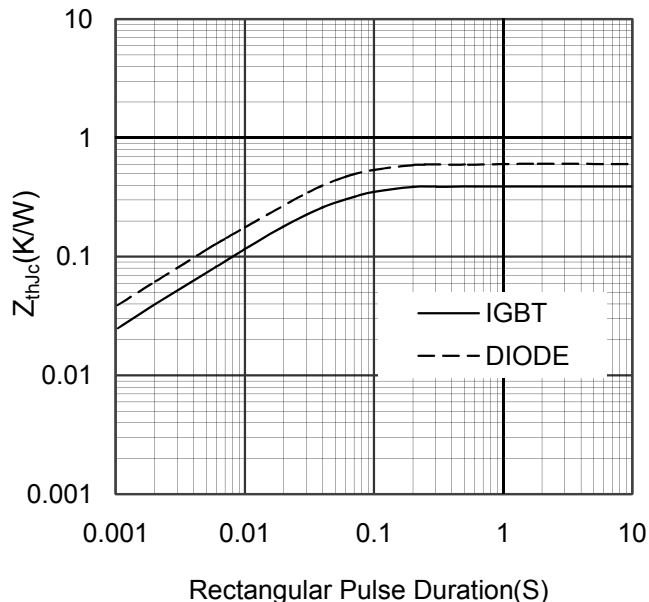

Figure 10. Transient Thermal Impedance of Diode and IGBT-inverter

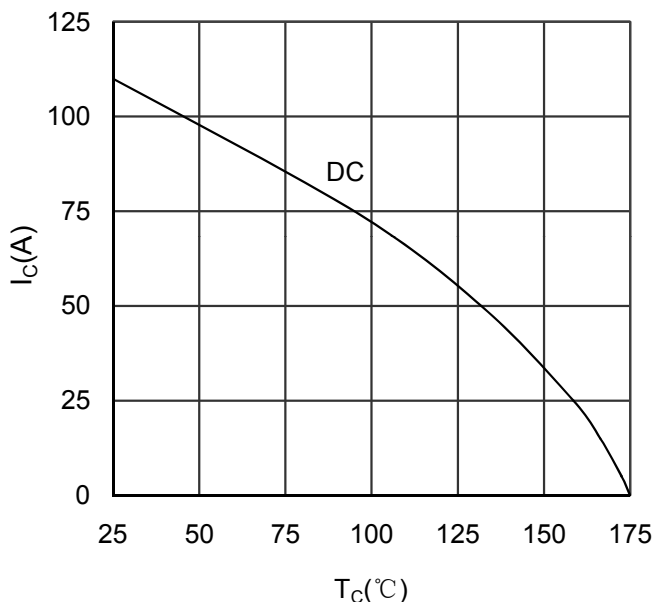

Figure 11. Collector Current vs Case temperature IGBT -inverter

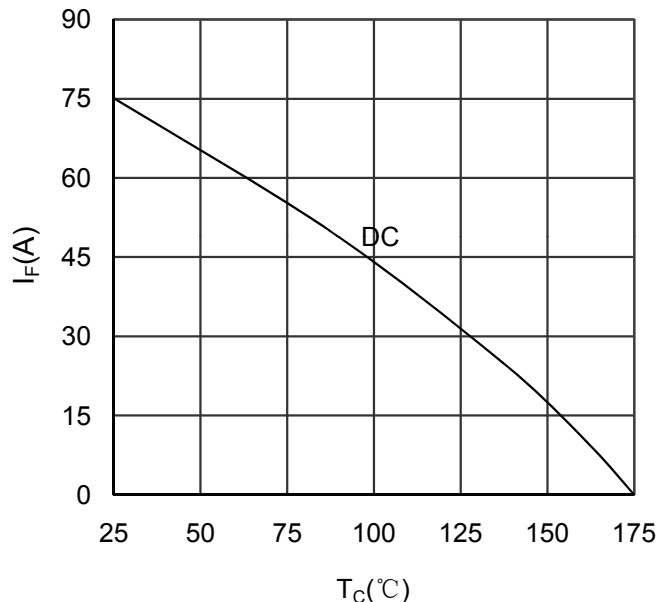

Figure 12. Forward current vs Case temperature Diode -inverter

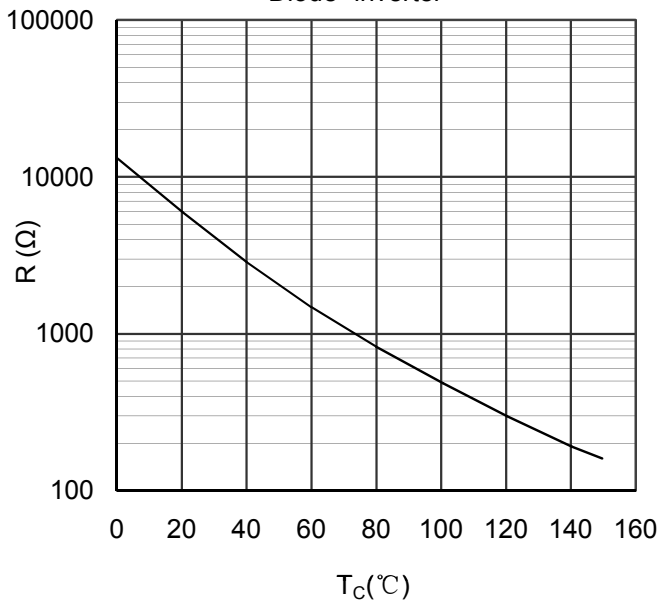

Figure 13. NTC Characteristics

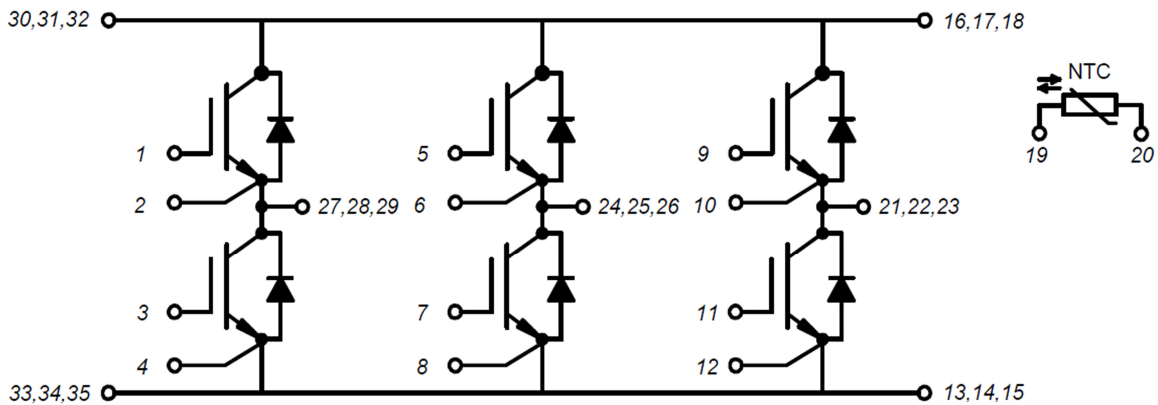

Figure 14. Circuit Diagram

